

FOCAL LENGTH (EFL): $250 \pm 2,5$
 BACK FOCAL LENGTH (BFL): $244,32$

1 BLACKENED SURFACE

SURFACE A	SURFACE B	SURFACE C
$\varnothing e 39$	$\varnothing e 39$	$\varnothing e 39$
CEMENT: NOA 61 OR EQUIVALENT		

PROTECTIVE CHAMFERS AS NEEDED		FIRST ANGLE PROJECTION			
ROHS: COMPLIANT	SCALE: NONE $\lambda = 587,6nm$				
SPECIFICATIONS SUBJECT TO CHANGE WITHOUT NOTICE. DIMENSIONS ARE FOR REFERENCE ONLY			TITLE 40mm Dia, x 250mm FL, VIS-NIR, Inked, Achromatic Lens		
FOR INFORMATION ONLY: DO NOT MANUFACTURE PARTS TO THIS DRAWING			ALL DIMS IN: mm	DWG NO 49384INK	SHEET SIZE A4
INDICATIONS IN ACCORDANCE WITH ISO 10110					

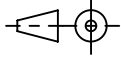
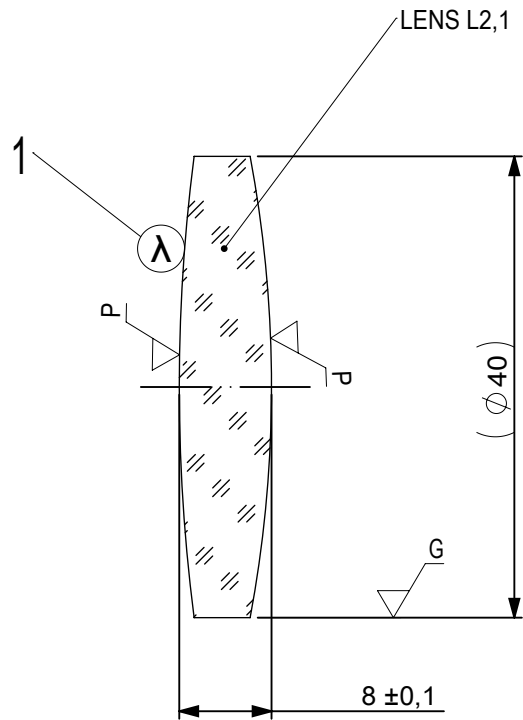

- 1 AR COATING: VIS-NIR
 R(ABS) ≤ 0,25% AT 880nm @ 0° AOI
 R(AVG) ≤ 1,25% FROM 400-870nm @ 0° AOI
 R(AVG) ≤ 1,25% FROM 890-1000nm @ 0° AOI

LEFT SURFACE	MATERIAL	RIGHT SURFACE
R 156±0,156 CX Øe 39 3/ 3 (0,5) λ=632,8 nm 4/ - 5/ 40 - 20 (MIL-PRF-13830B) 6/ -	GLASS N-BK7 517/642	R 108,7±0,109 CX Øe 39 3/ 3 (0,5) λ=632,8 nm 4/ - 5/ 40 - 20 (MIL-PRF-13830B) 6/ -

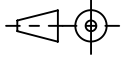
PROTECTIVE CHAMFERS AS NEEDED		FIRST ANGLE PROJECTION			
ROHS: COMPLIANT	SCALE: NONE λ = 587,6nm				
SPECIFICATIONS SUBJECT TO CHANGE WITHOUT NOTICE. DIMENSIONS ARE FOR REFERENCE ONLY			TITLE 40mm Dia, x 250mm FL, VIS-NIR, Inked, Achromatic Lens		
FOR INFORMATION ONLY: DO NOT MANUFACTURE PARTS TO THIS DRAWING			ALL DIMS IN: mm	DWG NO 49384INK	SHEET SIZE A4
INDICATIONS IN ACCORDANCE WITH ISO 10110					

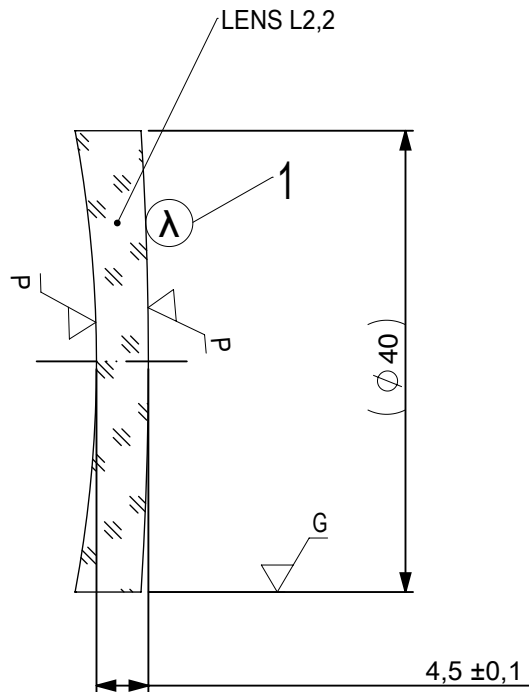

- 1 AR COATING: VIS-NIR
 R(ABS) ≤ 0,25% AT 880nm @ 0° AOI
 R(AVG) ≤ 1,25% FROM 400-870nm @ 0° AOI
 R(AVG) ≤ 1,25% FROM 890-1000nm @ 0° AOI

LEFT SURFACE	MATERIAL	RIGHT SURFACE
R 108,7±0,109 CV	GLASS N-SF5 673/322	R 313,64±0,314 CX
Øe 39		Øe 39
3/ 3 (0,5) λ=632,8 nm		3/ 3 (0,5) λ=632,8 nm
4/ -		4/ -
5/ 40 - 20 (MIL-PRF-13830B)		5/ 40 - 20 (MIL-PRF-13830B)
6/ -		6/ -

PROTECTIVE CHAMFERS AS NEEDED

ROHS: COMPLIANT
 SCALE: NONE λ = 587,6nm

SPECIFICATIONS SUBJECT TO CHANGE WITHOUT NOTICE. DIMENSIONS ARE FOR REFERENCE ONLY

FOR INFORMATION ONLY: DO NOT MANUFACTURE PARTS TO THIS DRAWING

INDICATIONS IN ACCORDANCE WITH ISO 10110

FIRST ANGLE PROJECTION

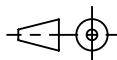

ALL DIMS IN: mm



Edmund Optics®

TITLE

40mm Dia, x 250mm FL, VIS-NIR, Inked, Achromatic Lens

DWG NO

49384INK

SHEET SIZE
A4

SHEET
3 OF 3