

NOTES:

1. ELEMENT A: 45803
2. ELEMENT B: 45805

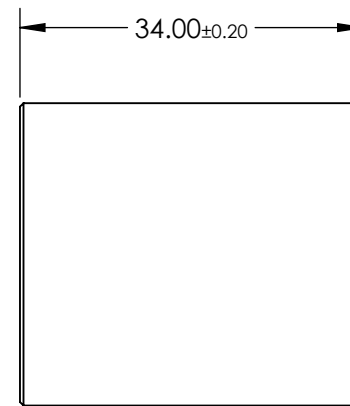
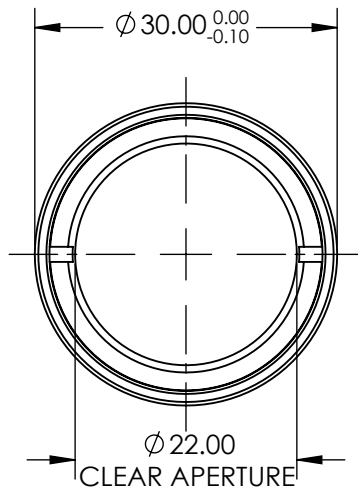
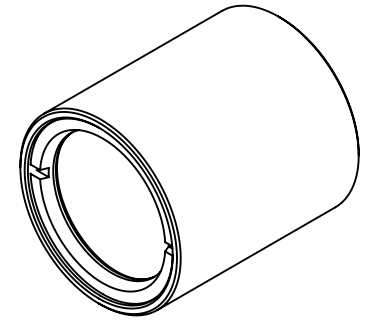

SPECIFICATIONS SUBJECT TO CHANGE WITHOUT NOTICE
DIMENSIONS ARE FOR REFERENCE ONLY

**FOR INFORMATION ONLY:
DO NOT MANUFACTURE
PARTS TO THIS DRAWING**

EO® Edmund Optics®

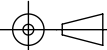
THIRD ANGLE PROJECTION 		TITLE	1:1.5 WITH 50mm AND 75mm EFL ACHROMATS, NIR ACHROMATIC PAIR	
ALL DIMS IN	mm	DWG NO	47299	SHEET 1 OF 1