

NOTES:

1. SUBSTRATE:
FUSED SILICA MOUNTED IN BLACK ANODIZED ALUMINUM RING
2. TRANSMITTED WAVEFRONT ERROR: $\lambda/4$
3. RoHS: COMPLIANT

**FOR INFORMATION ONLY:
DO NOT MANUFACTURE
PARTS TO THIS DRAWING**

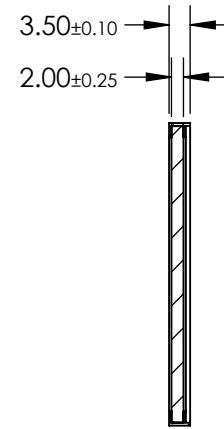
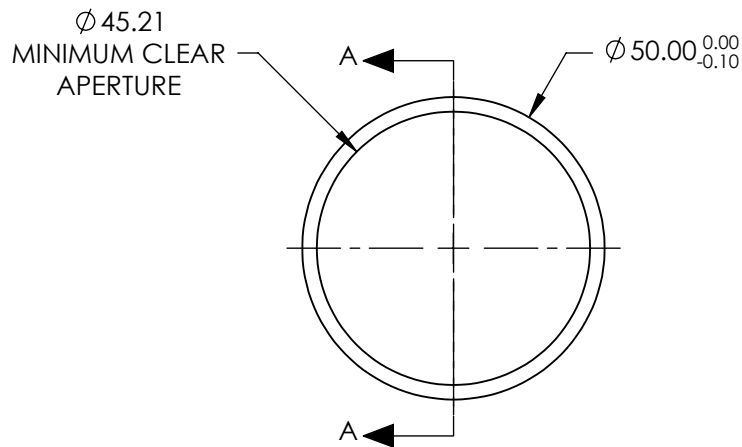

SECTION A-A

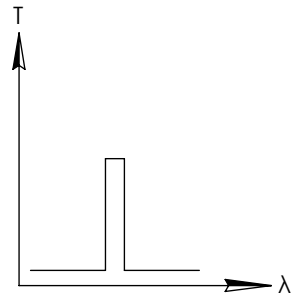

BANDPASS FILTER

	VALUE
CENTER WAVELENGTH (CWL) (nm)	648 ± 3nm
MINIMUM BANDWIDTH (nm)	14
FULL WIDTH HALF MAX (FWHM) (nm)	20
MINIMUM TRANSMISSION (%)	>93
OD6 BLOCKING RANGE (nm)	300 - 621 & 677 - 925
SURFACE QUALITY	60-40
COATING TYPE	HARD COATED
DURABILITY	MIL-C-48479A, SECT. 3.4.1
ENVIRONMENTAL	MIL-STD-801F, SECT. 507 .4

SPECIFICATIONS SUBJECT TO CHANGE WITHOUT NOTICE
DIMENSIONS ARE FOR REFERENCE ONLY

EO® Edmund Optics®

THIRD ANGLE PROJECTION

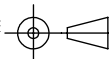

TITLE

OD6, Ø50mm, 648nm x 14nm, BP
FLUORESCENCE FILTER

ALL DIMS IN

mm

DWG NO

33337

SHEET
1 OF 1